



# ROITHNER LASERTECHNIK GmbH

WIEDNER HAUPTSTRASSE 76  
TEL. +43 1 586 52 43 -O. FAX. -44

1040 VIENNA AUSTRIA  
OFFICE@ROITHNER-LASER.COM



## UVTOP270-HL-T039

- Deep Ultraviolet Light Emission Source
- 275 nm, 0.6 mW
- TO39 Package
- Hemispherical Sapphire Lens
-  Water Sterilization, DNA Sequencing



### Description

**UVTOP270-HL-T039** is a deep ultraviolet light emission source, based on **AlGaN** quantum structures, typically emitting at **275 nm** with an optical output power of **0.6 mW**. It comes in hermetically sealed TO39 metal can package with a hemispherical sapphire lens, is Lead-free, and RoHS compliant. **UVTOP270-HL-T039** is widely used for forensic analysis, disinfection, **water sterilization**, protein analysis, DNA sequencing and drug discovery.

### Maximum Rating ( $T_{CASE} = 25^{\circ}C$ )

Parameter	Symbol	Values		Unit
		Min.	Max.	
Power Dissipation, DC	$P_D$		180	mW
Forward Current*	$I_F$		30	mA
Operating Temperature*	$T_{OPR}$	- 30	+ 55	$^{\circ}C$
Storage Temperature	$T_{STG}$	- 30	+ 100	$^{\circ}C$
Soldering Temperature	$T_{SOL}$		+ 190	$^{\circ}C$

\* Operation close to the absolute maximum ratings may affect device reliability

### Electro-Optical Characteristics ( $T_{CASE} = 25^{\circ}C$ , $I_F = 20$ mA)

Parameter	Symbol	Values			Unit
		Min.	Typ.	Max.	
Peak Wavelength <sup>*1</sup>	$\lambda_P$	270		280	nm
Spectral Width (FWHM)	$\Delta\lambda$		11	15	nm
Forward Voltage <sup>*2</sup>	$V_F$		6.0	7.0	V
Radiated Power <sup>*3</sup>	$P_O$	0.4	0.6		mW
Beam Angle	$2\Theta_{1/2}$		7		deg.
Thermal Resistance	$R_{th}$		50		$^{\circ}C/W$

<sup>\*1</sup>wavelength measurement tolerance:  $\pm 3$  nm

<sup>\*2</sup>forward voltage measurement tolerance:  $\pm 3$  %

<sup>\*3</sup>output power measurement tolerance:  $\pm 10$  %



## Performance Characteristics

### Forward Current vs. Forward Voltage

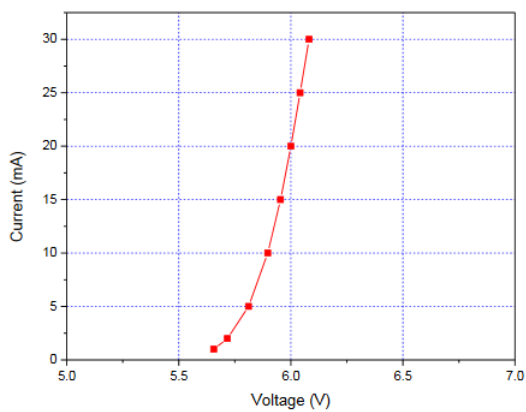

### Rel. Optical Power vs. Forward Current

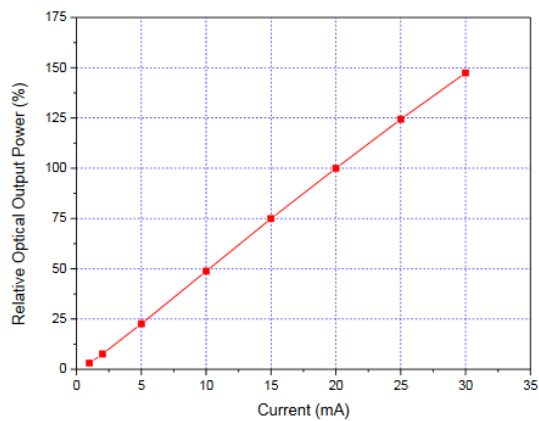

### Peak Wavelength vs. Forward Current

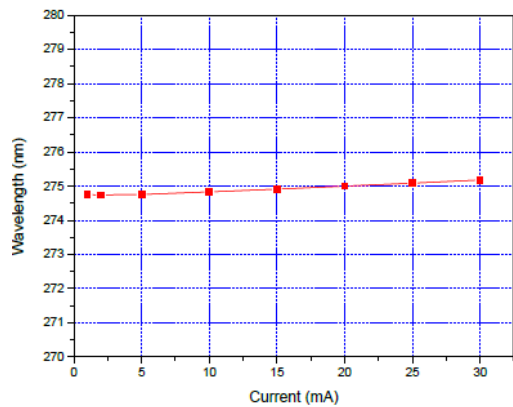

### Rel. Optical Power vs. Case Temperature

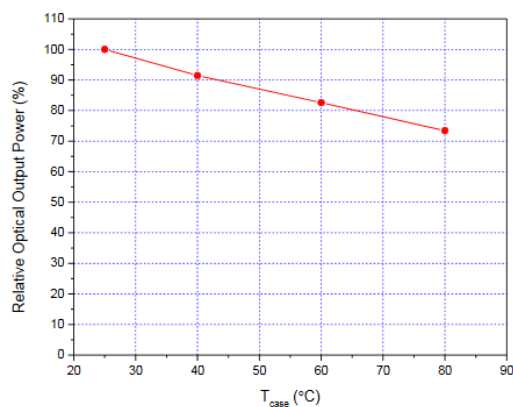

### Peak Wavelength vs. case Temperature

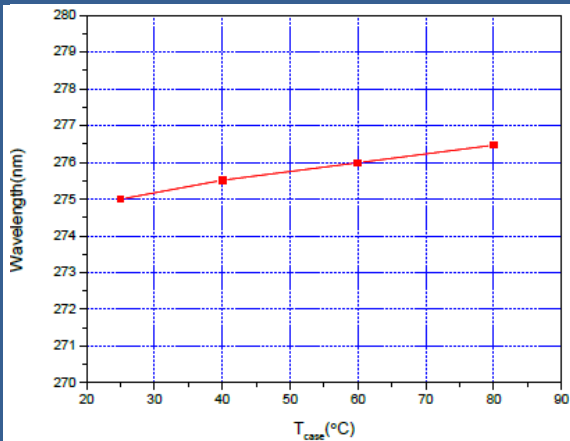

### Forward Voltage vs. Case Temperature

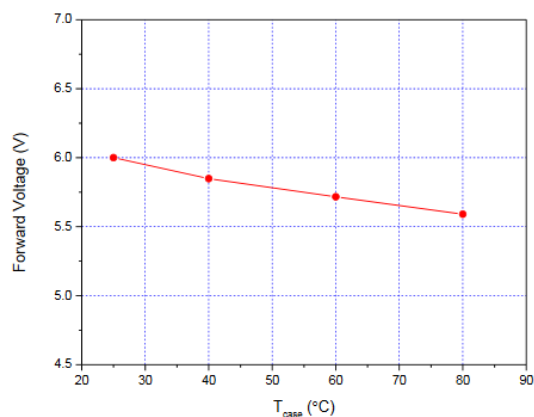



## Performance Characteristics

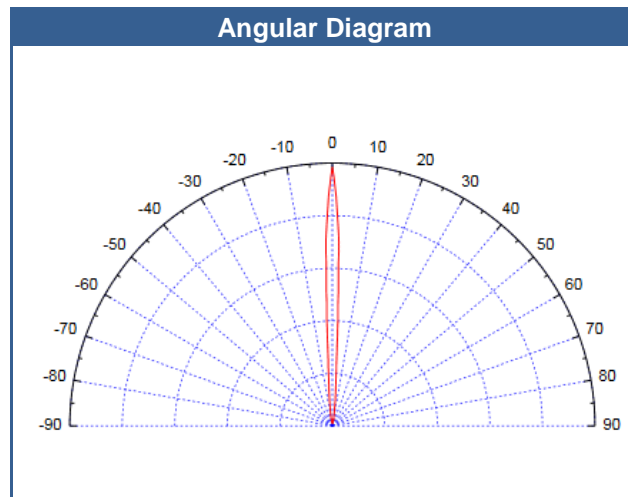
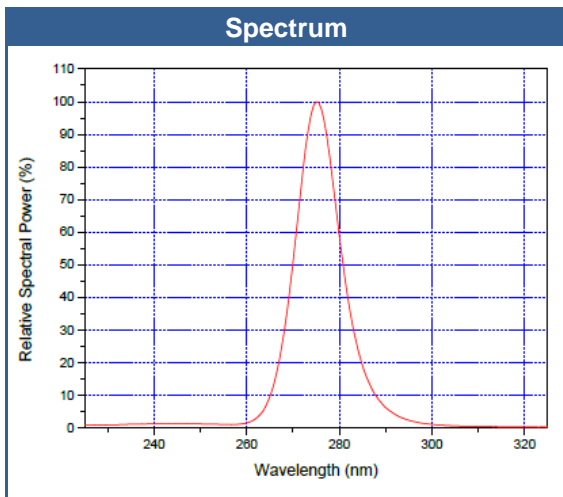

## Outline Dimensions

### TO-39 hemispherical lens

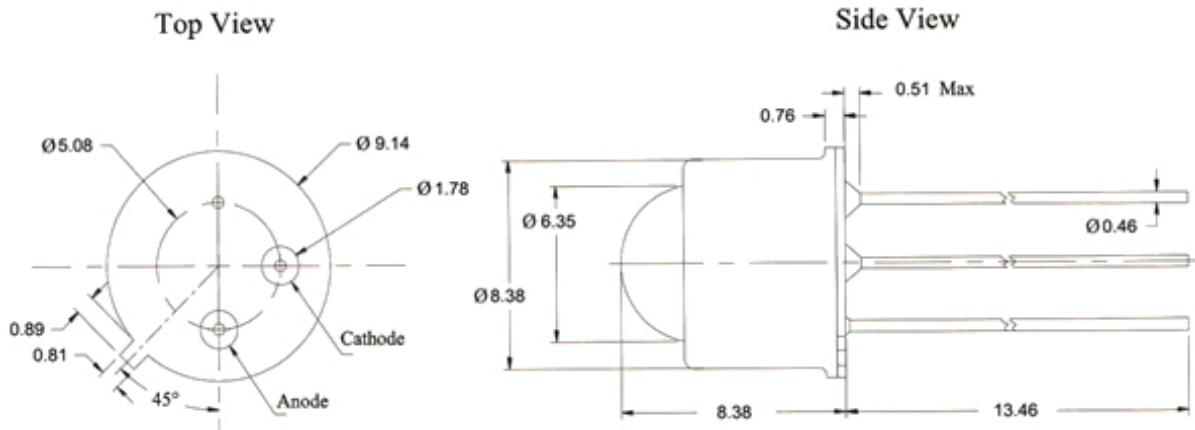

All dimensions in mm

## Electrical Connection

Pin #	Function
Pin 1	Anode
Pin 2	Cathode
Pin 3	Case

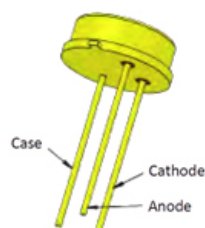

### Bottom View:

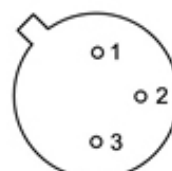



## Precautions

### Soldering:

- Do avoid overheating of the LED
- Do avoid electrostatic discharge (ESD)
- Do avoid mechanical stress, shock, and vibration
- Do only use non-corrosive flux.
- Do only solder the leads. Soldering of header or cap will damage the LED
- Do only cut the leads at room temperature with an ESD protected tool
- Do not solder closer than 3 mm from base of the header
- Do form leads prior to soldering
- Do not impose mechanical stress on the header when forming the leads
- Do not apply current to the LED until it has cooled down to room temperature after soldering

### Recommended soldering conditions:

dip soldering		hand soldering	
pre-heat time	max 30 s	soldering time	max 5 s
dipping time	max 5 s		
solder bath temperature	max 190 °C	solder temperature	max 190 °C

It is strongly advised to perform soldering at the shortest time and lowest temperature possible.



### Cleaning:

Cleaning with isopropyl alcohol, propanol, or ethyl alcohol is recommended

DO NOT USE acetone, chloroform, trichloroethylene, or MKS

DO NOT USE ultrasonic cleaners

### Static Electricity:

UVTOP are sensitive to electrostatic discharge (ESD). Precautions against ESD must be taken when handling or operating these LEDs. Surge voltage or electrostatic discharge can result in complete failure of the device.

### UV-Radiation:

During operation these LEDs do emit **high intensity ultraviolet light**, which is hazardous to skin and eyes, and may cause cancer. Do avoid exposure to the emitted UV light. **Protective glasses are recommended.** It is further advised to attach a warning label on products/systems that do utilize UV-LEDs:



### Operation:

Do **only** operate UVTOP LEDs with a current source.

Running these LEDs from a voltage source *will* result in complete failure of the device.

Current of a LED is an exponential function of the voltage across it. Usage of current regulated drive circuits is mandatory





## Device Materials

Pin #	Material
Header	Fe-Ni alloy, plated Ni-Au
Leads	Fe-Ni alloy, plated Ni-Au
Bonding wires	Au
Lens	SiO <sub>2</sub>



© All Rights Reserved

The above specifications are for reference purpose only and subjected to change without prior notice